

Classic and Colonial Wood Venetian Blind Fitting Instructions

Please find enclosed appropriate brackets and screws for either top fix or face fix.

1. Fixings

2 x end cover brackets (marked LH and RH)
1 x centre support (if over 1600mm)
4 x screws (6 with support)

For blinds over 1600mm a centre bracket will provide support for the additional weight.

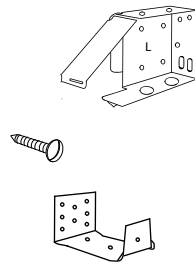

2. Method of fitting blinds

Your blinds were made to be fitted either outside the recess or inside the recess. Please follow the instructions that apply to your blind.

For inside recess blinds a 10mm deduction has been made for ease of fitting.

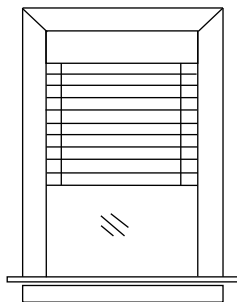

inside recess

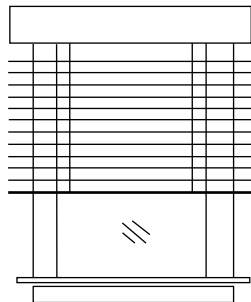

outside recess

3. Mounting the brackets

The mounting brackets may be mounted using the screws provided in several different orientations depending on your needs - see illustration below.

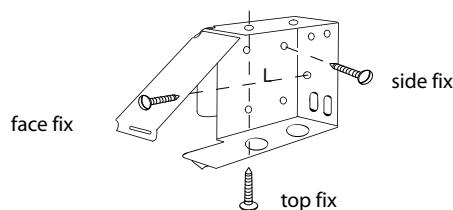

4. Measure for fitting

First measure cassette box with brackets on. Then mark the area where you intend to fit, and screw brackets in place (with catch facing out). When brackets are in place slide head cassette box into the brackets horizontally. Secure by clipping catches over - see illustrations A and B.

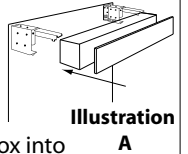
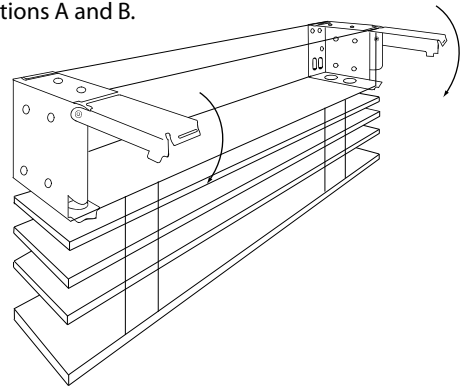

Illustration A

Illustration B



5. Valance

With your wood venetian blind you will be provided with a valance to cover the front of the cassette box. This attaches simply by velcro. See section 6 for valance returns.

6. Valance returns for outside recess

A mitred valance for the returns will be supplied as standard on blinds fitted outside the recess. When measuring for outside recess please note that the mitred returns will add an additional 16mm to the overall blind size.

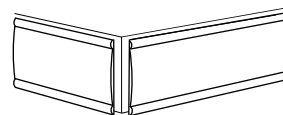

mitred corner for valance

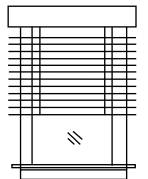

7. Operating your blind

Tilt (Single Cord Acorn)

To tilt your slated blind pull either of the single acorn cords.

Raise or Lower (Multi-cord Acorn)

Slat's should be fully open, not tilted when raising or lowering. To raise the blind pull the cord straight down. To lower the blind pull the cords towards the centre of the blind and slowly raise your hand while holding on to the cords. Move the cord back to the vertical position and the cord lock holds the blind in position.

6. Cleaning

We recommend routine dusting with a soft brush, cloth or alternatively clean them with a vacuum cleaner brush attachment. If blinds become soiled, they may be cleaned with a soft cloth dampened with warm water. You may want to add a small amount of mild, non-abrasive liquid soap to the warm water. We advise you to utilize professional window treatment cleaning services if you have elected to have your blind cleaned by methods other than those suggested above.



WARNING

PARENTS SHOULD KNOW THAT CHILDREN COULD ACCIDENTALLY STRANGLE IN WINDOW COVERING CORDS.
KEEP CORDS OUT OF THE REACH OF CHILDREN

Any queries do not hesitate to call 01843 608780